

CUSTOMER TERMINAL	ROHS	Lead(Pb)-free
	YES	YES

## 1.Mechanical Dimensions

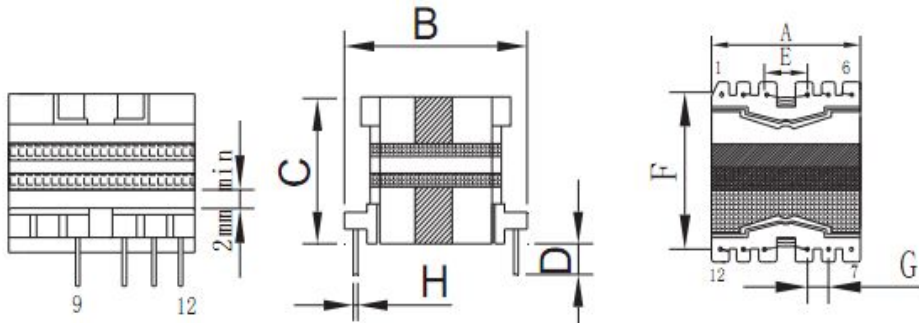

A	29.5	MAX
B	30.5	MAX
C	23.5	MAX
D	3.0	±0.5
E	7.6	±0.3
F	25.4	±0.4
G	3.8	±0.3
H	0.60	±0.1

## 3.Material List

Core:FW95 PQ2620

Bobbin:FWB2601(6+6PIN)

Wire:2UEW TIW

Copper foil: 0.025t\*8.0mm

Operating Temperature: -30 to115 °C

## 2.Schematic Diagram

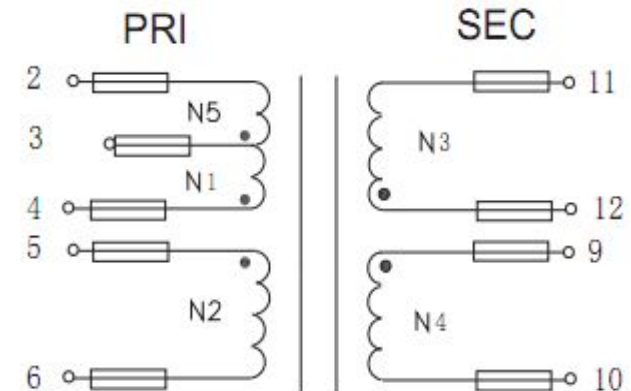

## 4.Electrical Specification

Inductance: L(4-2):990uH±5% 40KHZ 、 1V

Leakage Inductance : 20uH MAX 40KHZ 、 1V

DCR:(4-2)=0.65ΩMAX (10-9)=0.46ΩMAX

Hi-Pot:P-S: AC 60Hz 4000V 1.0mA 3S

P-CORE: AC 60Hz 500V 1.0mA 3S

REV.	DATE	<p>Convention Placement</p>	DRW.		Drawing Title:	Part No:
0	00/00		CHK.			
ROHS			<a href="http://www.ferriwo.com">www.ferriwo.com</a>	APP.		Customer P/N